

Kood	Suitsusaun	Leht	2
Joonis	WALL A	Moodkava	1:35
Materjal	7x13	Kuup.	01.03.2007
Joonistas	K.Kahu	File	Suitsusaun.dwg

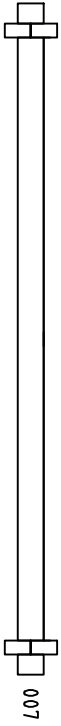

253.5

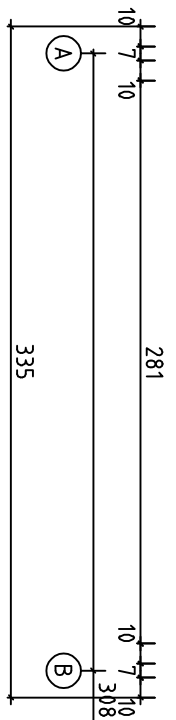
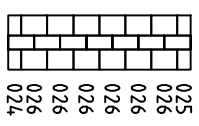
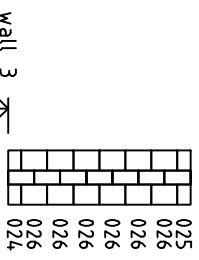

Kood	Suitsusaun	Leht	6
Joonis	WALL 3	Moodkava	1:35
Materjal	7x13	Kuup.	01.03.2007
Joonistas	K.Kahv	File	Suitsusaun.dwg

600x400 - 1 komplekt

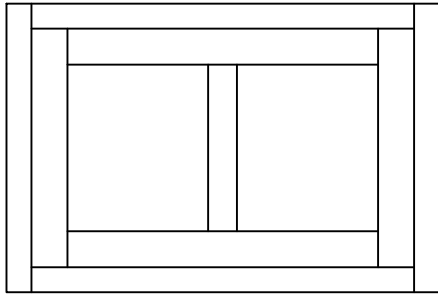

Border boards 19x140

880mm 2pcs

560mm 2pcs

520mm 4pcs

Window fixing slat 20x28

400mm 2pcs

Window fixing board 19x70

400mm 2pcs

800x1800 - 1 komplekt

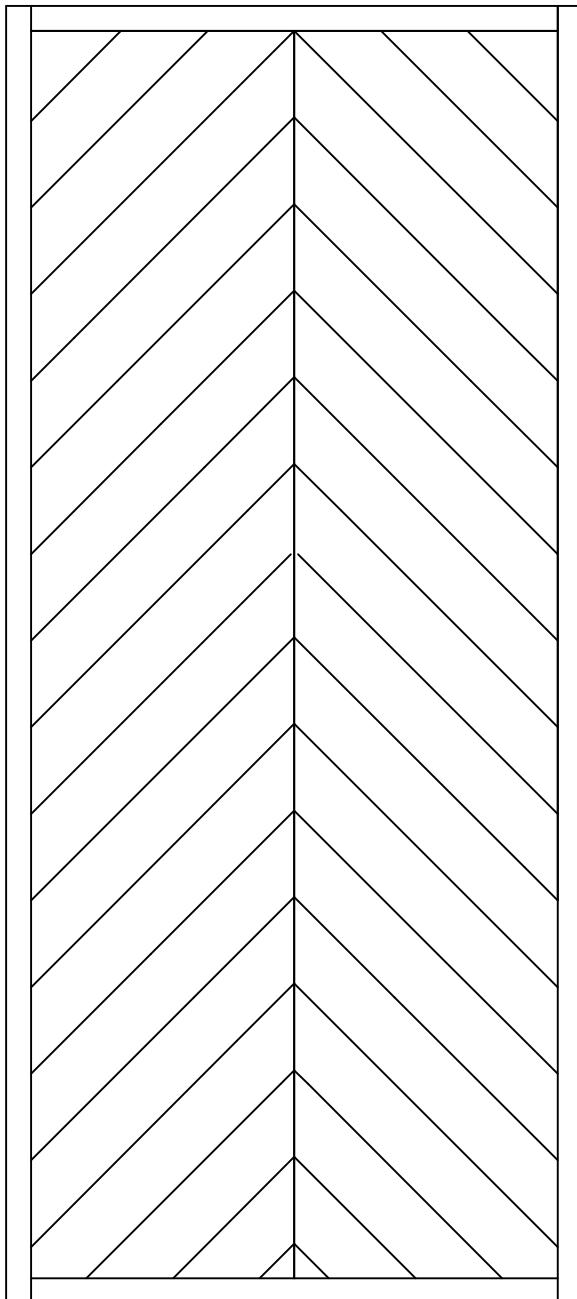

Border boards 19x140

1780mm 4pcs

1080mm 2pcs

Door fixing slat 20x28

1800mm 2pcs

Door fixing board 19x70

1800mm 2pcs

Shutters

600x150x6mm 2pcs (plywood)

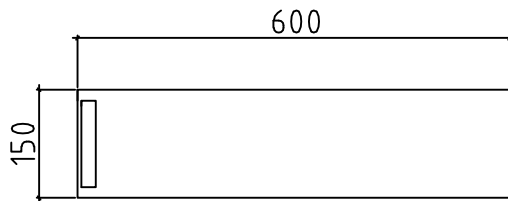

Handles

20x20x120 2pcs

Sliding slats 30x40x1160 4pcs

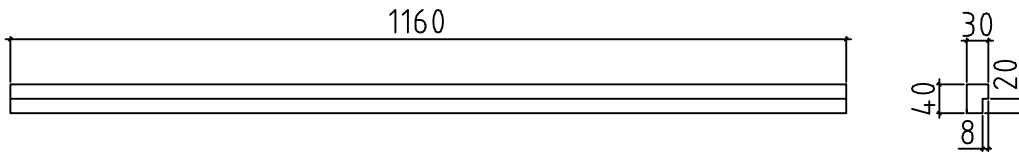

400x300x6mm 2pcs (plywood)

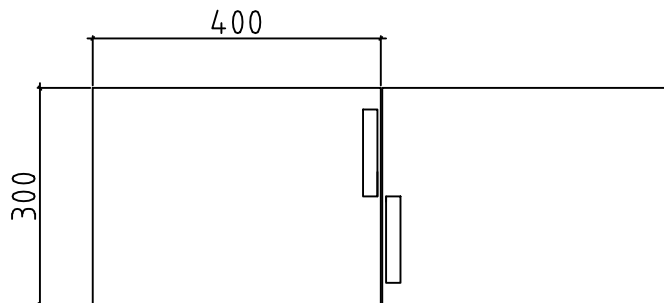

Handles

20x20x120 2pcs

Sliding slats 30x40x1460 2pcs

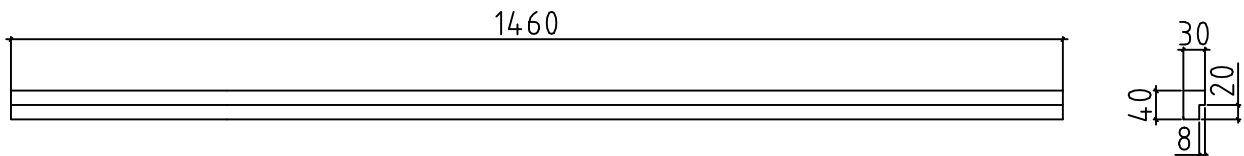

ROOFBOARD 19x...		
	2270mm	covers 2x4.95m
CEILING BOARD 11x...		
	1550 mm	covers 2x 3m
Ceiling board fixing slat 30x40 Pos11 3000mm 2pcs		
	Gable board 140x19 2320mm 2300mm	4 pcs 4 pcs
	Eave board 140x19 4950 mm	4 pcs
	Eave slat 40x30 4950 mm	2 pcs
	Board matching with gable board 19x90 2325mm	4 pcs
	Floorboard 19x... 980mm covers 1.96m place between boards 10mm 1980mm covers 1.96m place between boards 10mm 1130mm covers 1.04m place between boards 10mm	
	Terrace board 28x... x1200mm covers 3.0m place between boards 10mm	
Terrace border boards 19x120		
	1300mm 2pcs	
	75mm 4pcs	

FLOORBEAMS

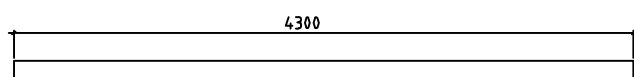

PT1/2
45x140

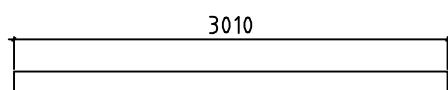

PT2/8
45x140

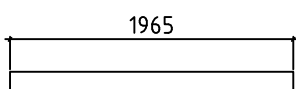

PT3/5
45x140

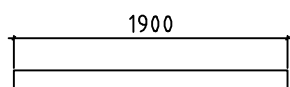

PT4/1
45x140

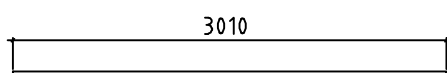

PT5/1
45x45

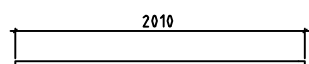

PT6/1
45x45

Slat 18x45

3010mm	1pc
2010mm	1pc

Slat 10x45

2010mm	1pc
--------	-----

Slat 30x40

3010mm	1pc
--------	-----

PURLINS

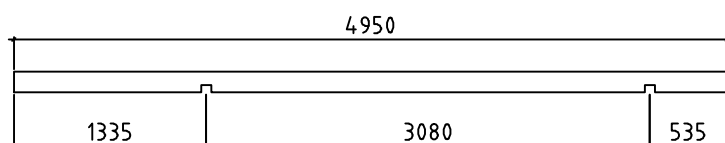

PR1 /3
70x140(70x90)

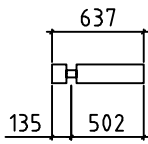

021 /1

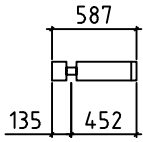

022 /3

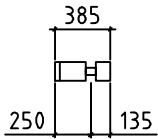

023 /14

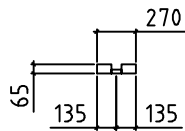

024 /2

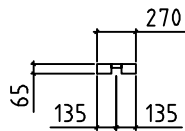

025 /2

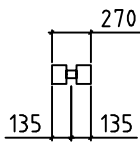

026 /18

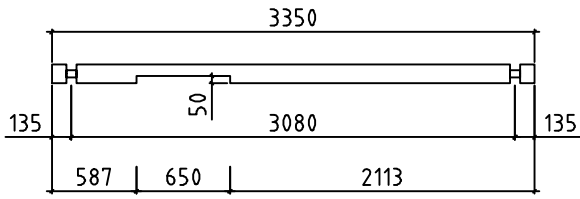

011 / 1

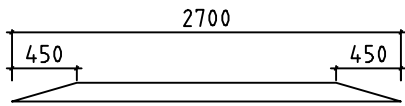

012 / 2

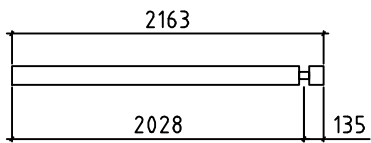

013 / 1

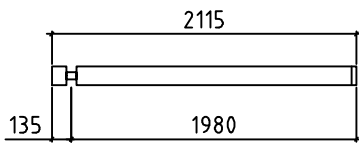

014 / 14

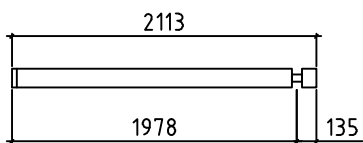

015 / 3

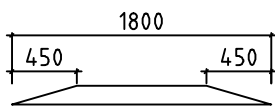

016 / 2

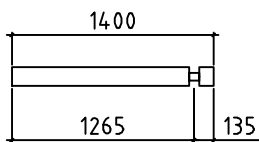

017 / 2

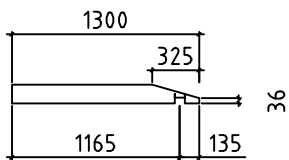

018 / 2

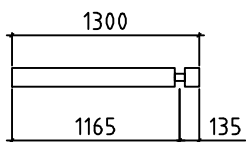

019 / 2

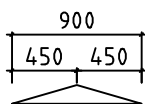

020 / 2

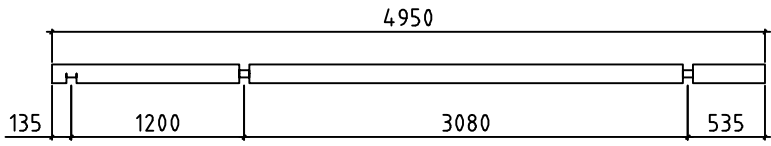

001 / 2

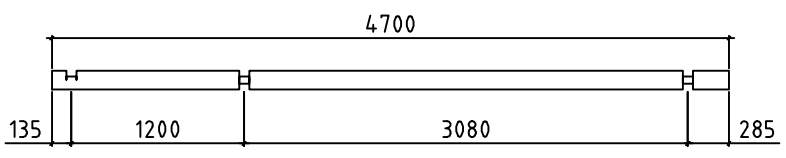

002 / 2

Terr osas
punnita

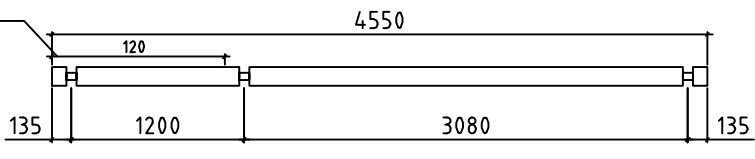

003 / 2
Terr. osas punnita

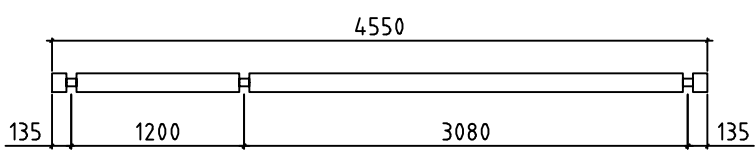

004 / 6

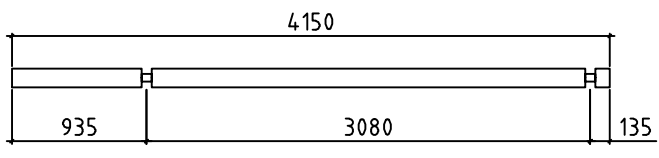

005 / 2

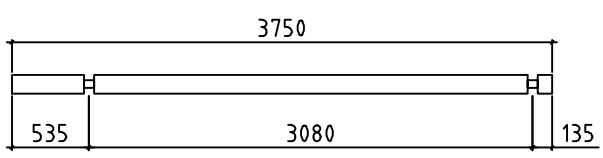

006 / 2

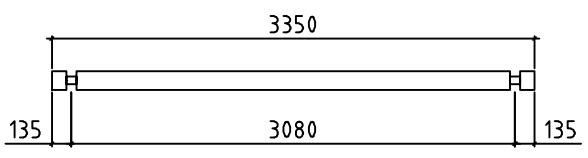

007 / 41

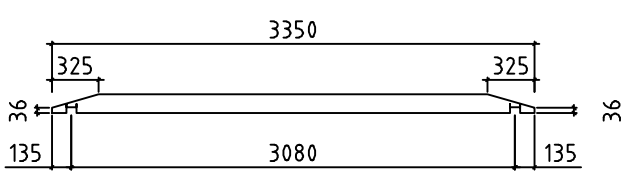

008 / 1

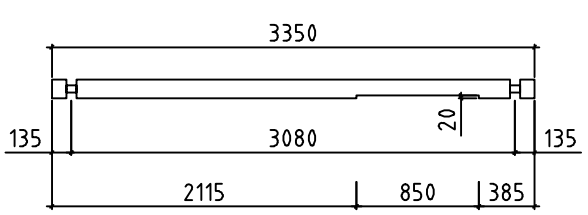

009 / 1

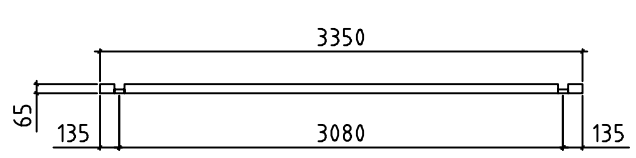

010 / 2

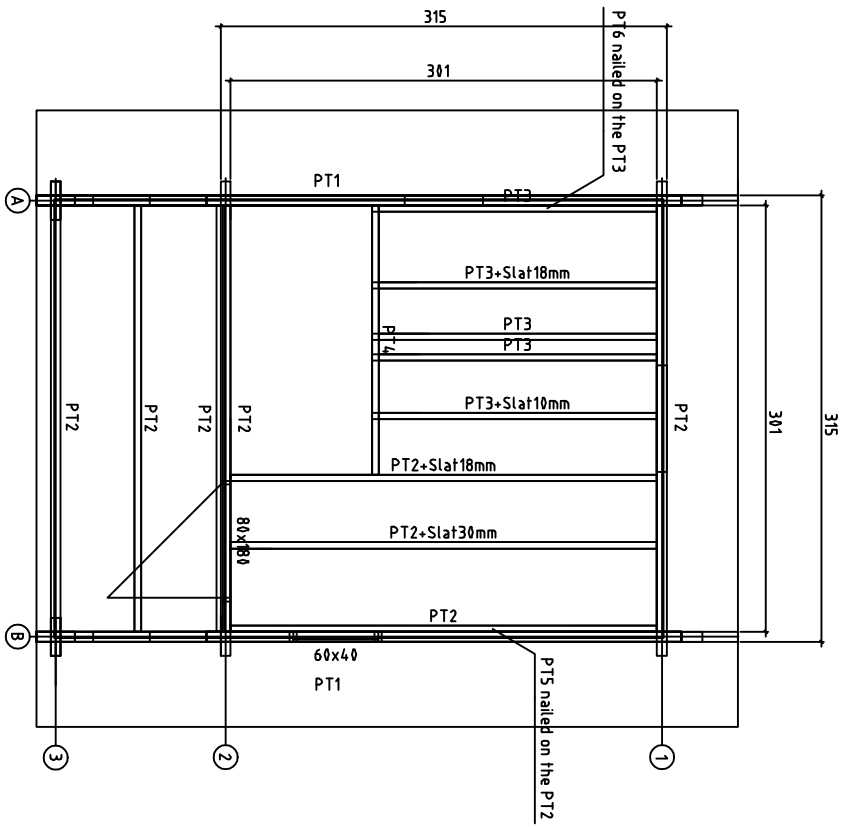

Kode	Suisusaun	Laki
Jenise	Plaan	Measures 1:35
Materjal	70x130	Kuip- 01.03.2007
Apeserte	K.Kahu	File Suisusaun.dwg

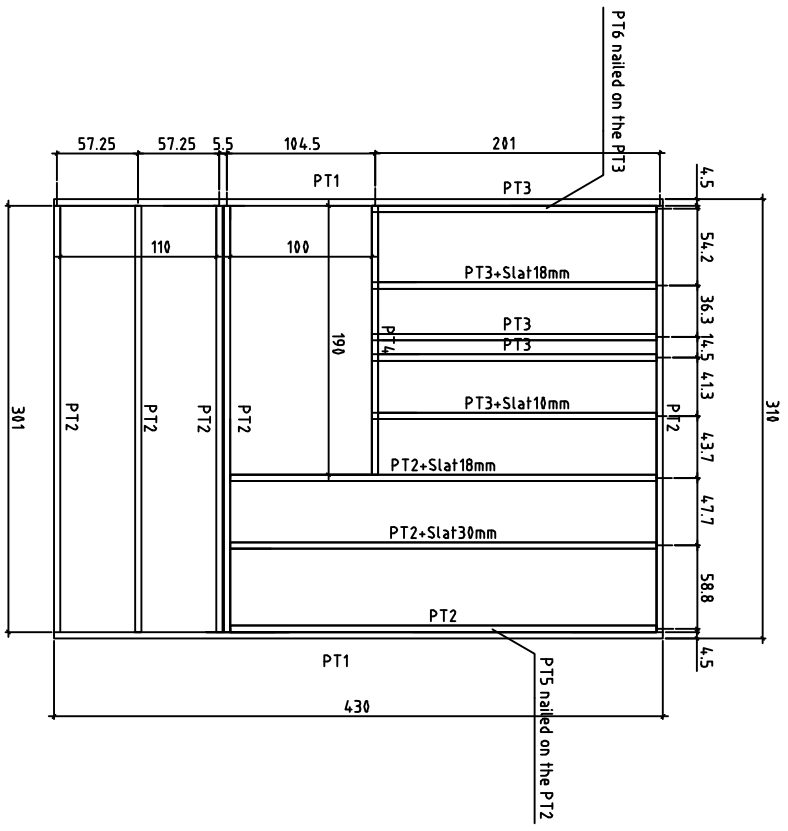

Kood	Suitsusaun	Leht
Jooni	Plaan	Kehtava 1:35
Materjal	70x130	Kaup. 01.03.2007
Arhitekt	K.Kahu	File Suitsusauna pörandafala

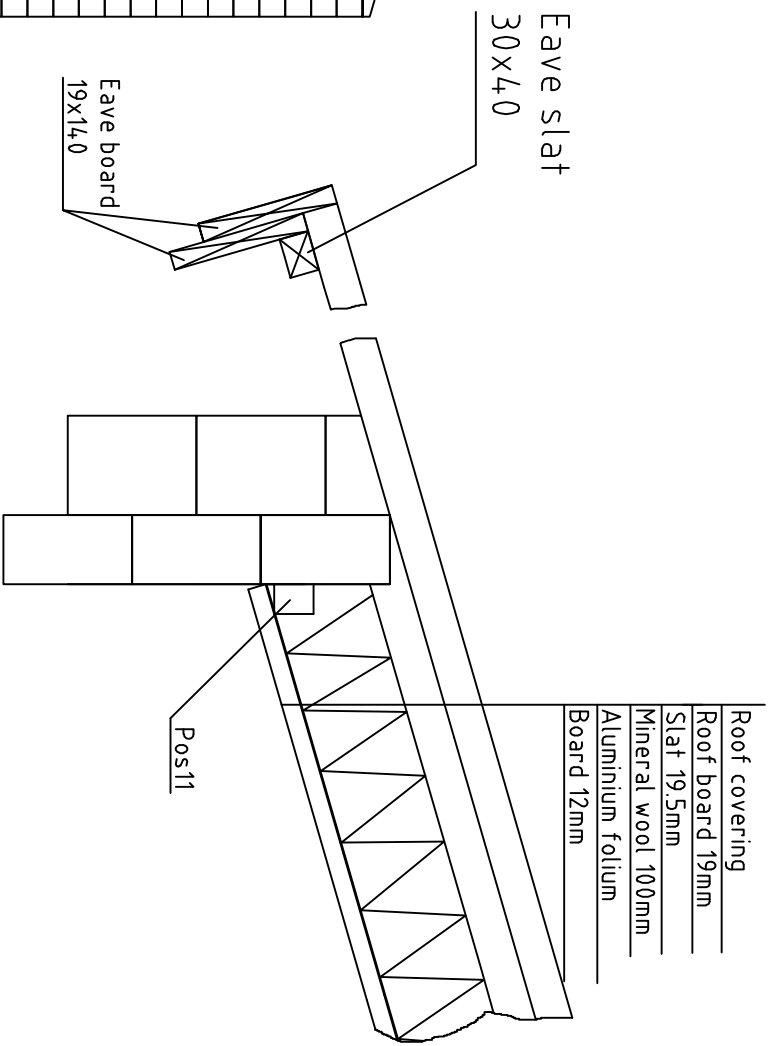
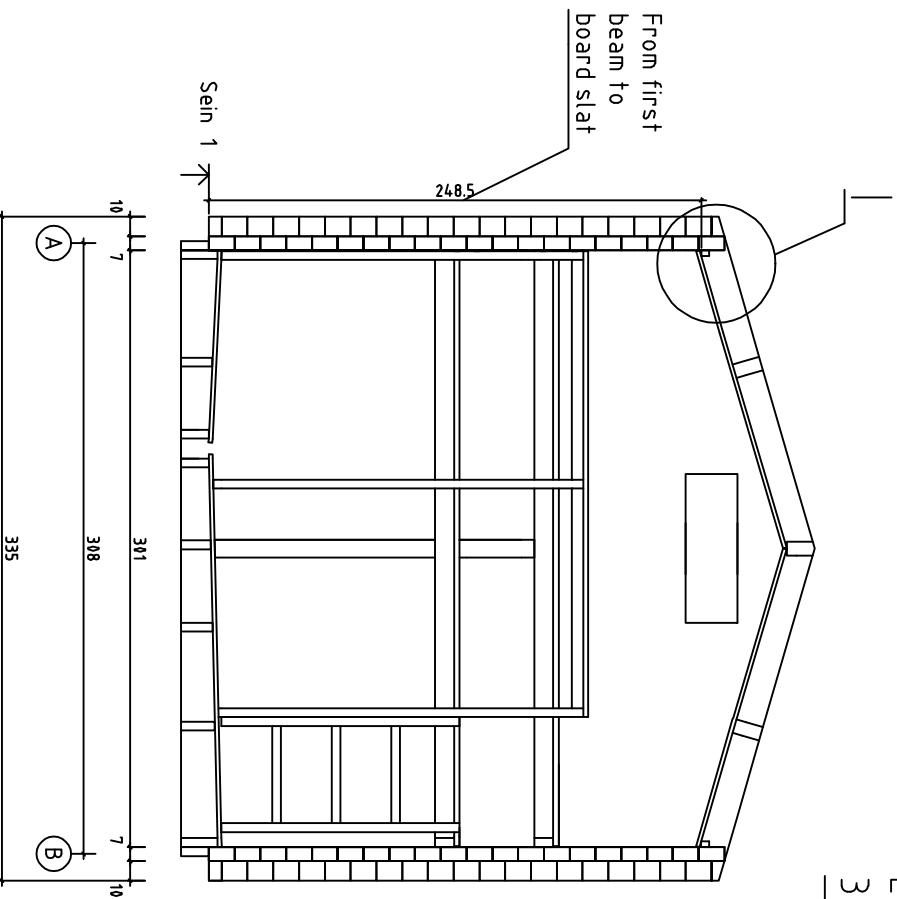

Kood	Suitsusauna lõige	Leht
Joonis	Lõige	Heiteva 1:25
Materjal	70x130	Koop. 01.03.2007
Arhitekt	K.Kahu	File Suitsusauna lõige.dwg

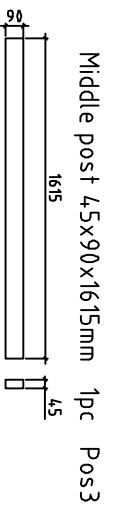

Middle post 4.5x90x1615mm 1pc Pos3

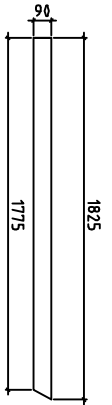

Post 4.5x90x1825 1pc Pos4

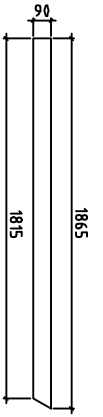

Post 4.5x90x1865 1pc Pos5

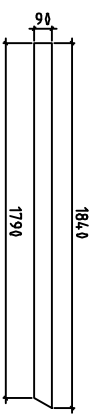

Post 4.5x90x1840 1pc Pos6

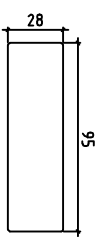

Board 28x140x2350 1pc Pos7

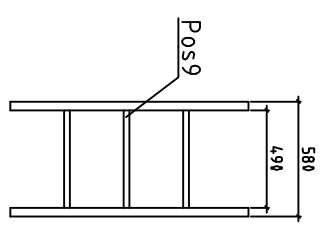

Pos9

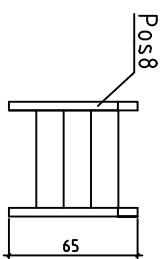

Pos8

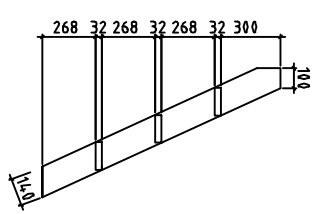

4.5x140x1360mm 2pcs Pos8

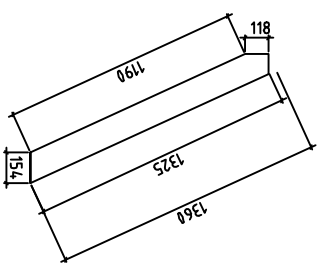

32x140x490mm 3pcs Pos9



Pos9

Kood	Suitsusauna tõiige	Leht
Joonis	Lõige	Heedatus 1:25
Materjal	70x130	Kaup- 01.03.2007
Arhitekt	K.Kahu	File Suitsusauna tõiige (avald)

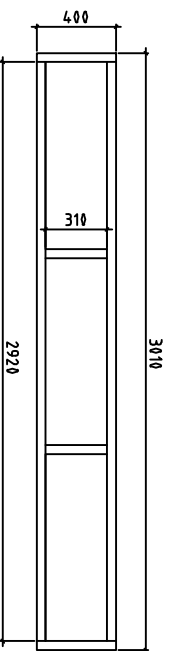
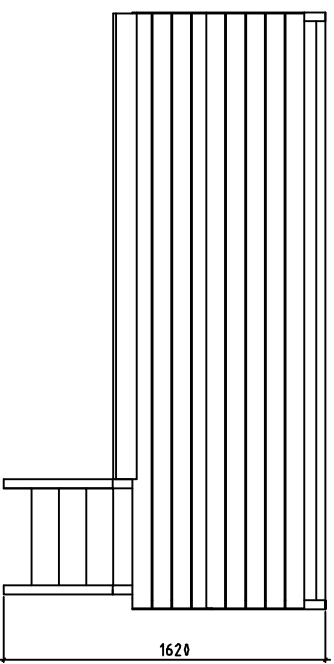
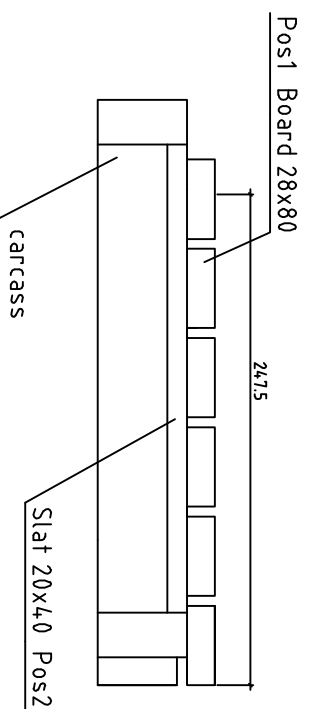
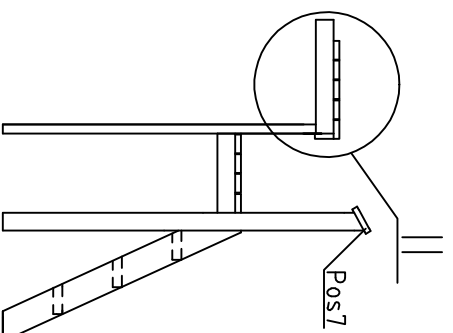
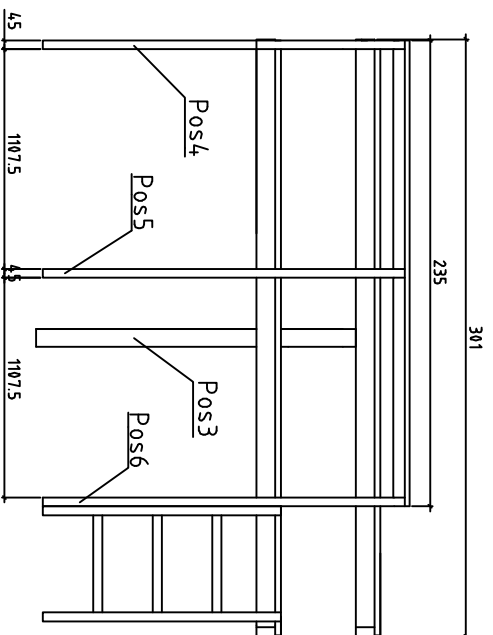

carcass 3010x400
 45x90x2920mm 2pcs
 45x90x400mm 2pcs
 45x90x310mm 2pcs

Boards 28x80x3000mm 12pcs Pos1

carcass 3010x560
 45x90x2920mm 2pcs
 45x90x560mm 2pcs
 45x90x470mm 2pcs

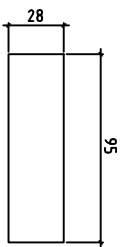
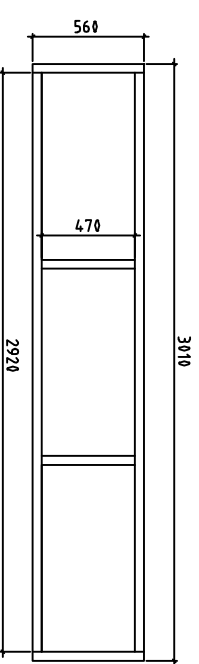

Slat for fixing boards 20x40 Pos2

470mm 4pcs
 310mm 4pcs

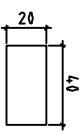

Kood	Suitsusauna tõiige	Leht
Asukoht	Lõige	Heiteku 1:25
Materjal	70x130	Kaup. 01.03.2007
Arhitekt	K.Kahu	File Suitsusauna tõiige lavakla

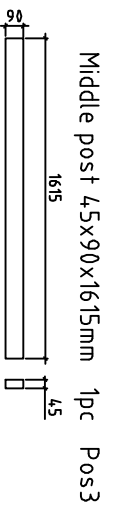

Middle post 4.5x90x1615mm 1pc Pos3

Post 4.5x90x1825 1pc Pos4

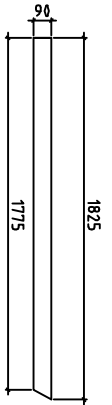

Post 4.5x90x1865 1pc Pos5

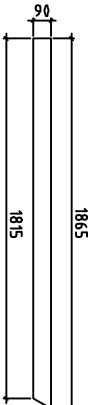

Post 4.5x90x1840 1pc Pos6

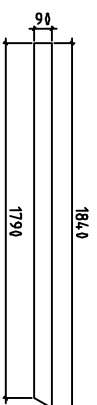

Board 28x140x2350 1pc Pos7

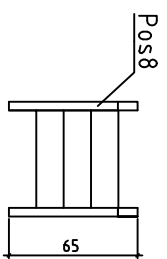
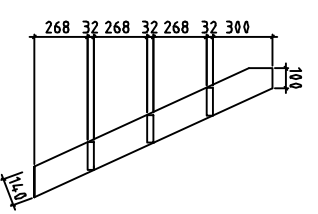
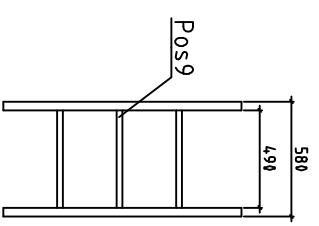
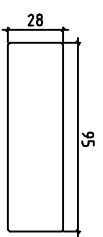

4.5x140x1360mm 2pcs Pos8

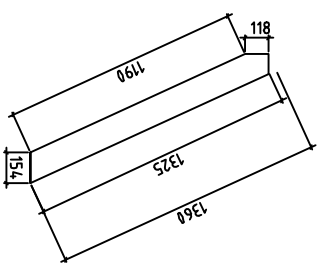

32x140x490mm 3pcs Pos9



Kood	Suitsusauna tõiige	Leht
Joonis	Lõige	Heitevahe 1:25
Materjal	70x130	Kaup- 01.03.2007
Arhitekt	K.Kahu	File Suitsusauna tõiige.dwg

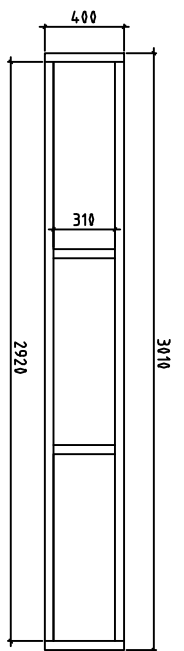
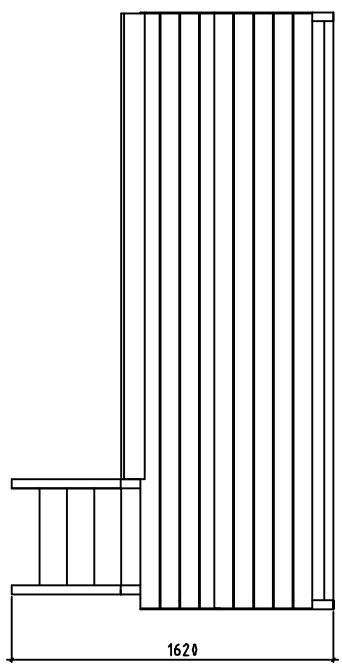
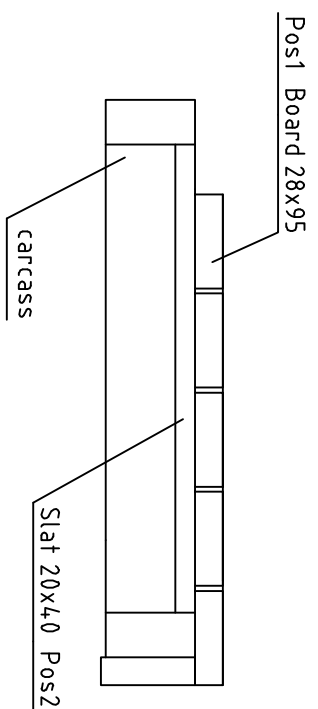
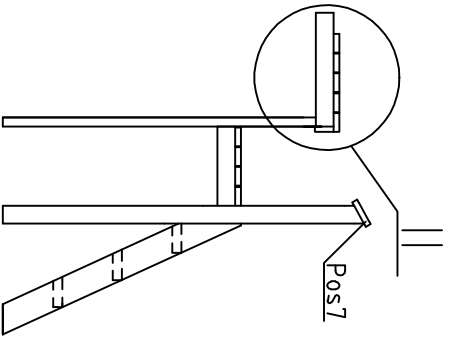
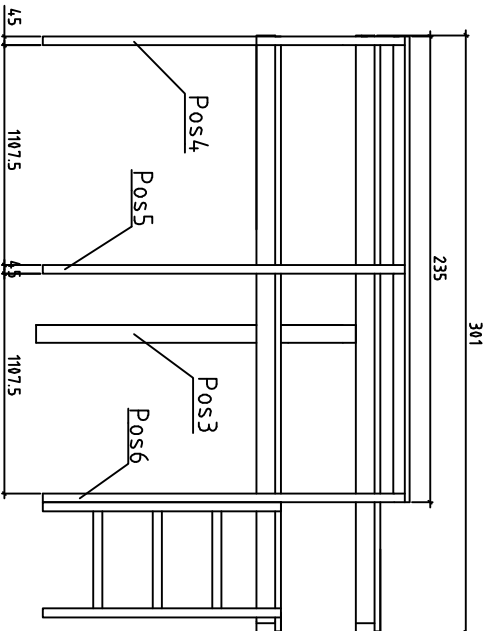

carcass 3010x400
 45x90x2920mm 2pcs
 45x90x400mm 2pcs
 45x90x310mm 2pcs

Boards 28x95x3000mm 10pcs Pos1

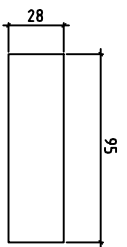

Slat for fixing boards 20x40 Pos2

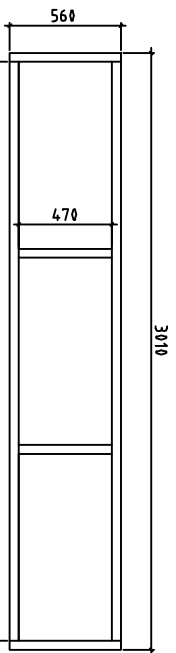
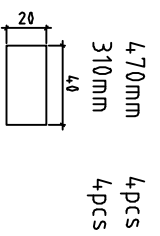

carcass 3010x560
 45x90x2920mm 2pcs
 45x90x560mm 2pcs
 45x90x470mm 2pcs

Kood	Suitsusauuna lõige	Leht
Asukoht	Lõige	Rehvino 1:25
Materjal	70x130	Kaup- 01.03.2007
Arhitekt	K.Kahu	File Suitsusauuna lõige.dwg

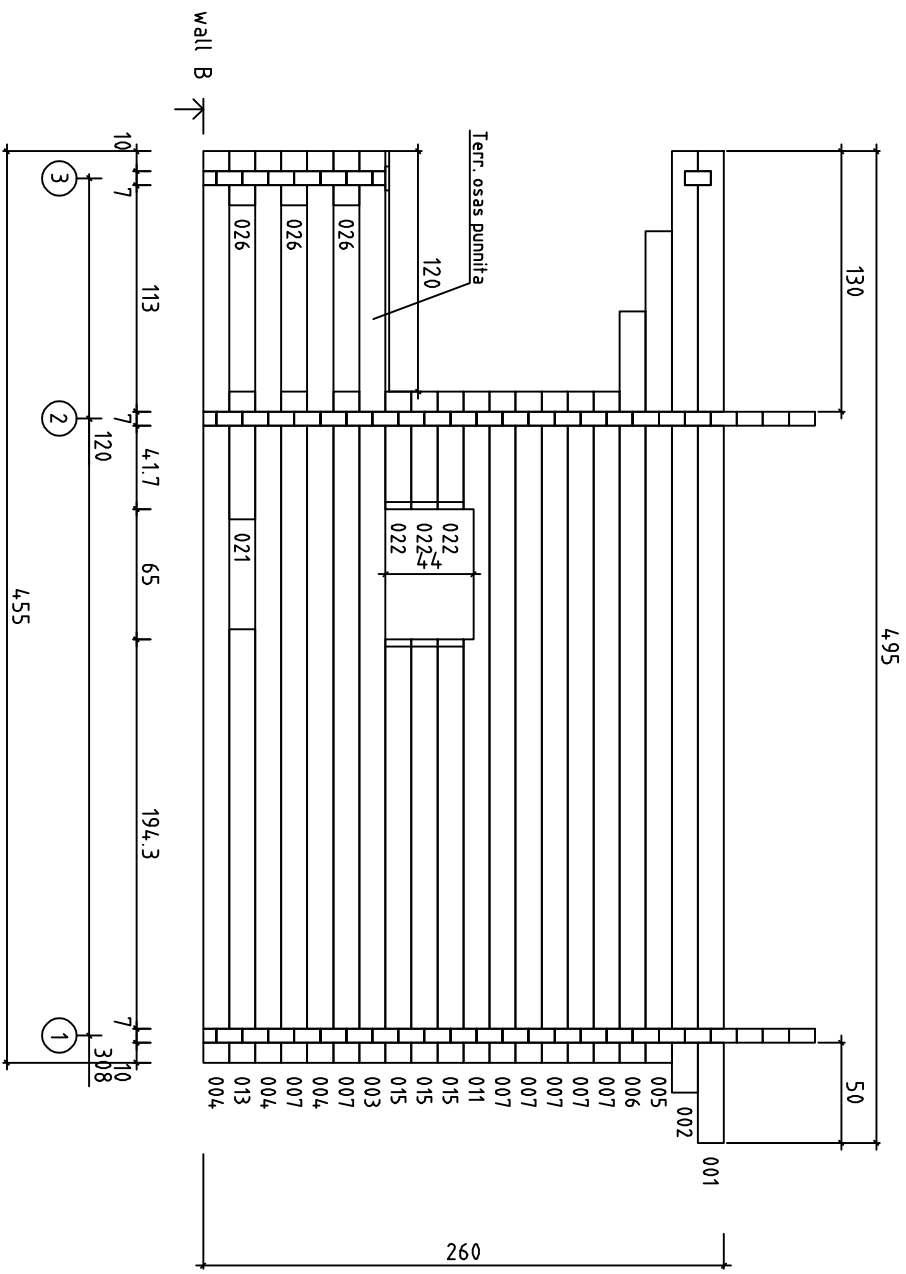

Kood	Suitsusaun	Leht	3
Joonis	WALL B	Moodkava	1:35
Materjal	7x13	Kuup.	01.03.2007
Joonistas	K.Kahu	File	Suitsusaun.dwg